



CLOUD12-P06



**12" RUGGED PANEL COMPUTER WITH INTEL®
KABYLAKE-U SOC 14NM CORE™ I7/I5/I3 BGA
TYPE, 6 FUNCTION KEYS**



POWER AUTOMATION COMPUTER

- Intel® Kabylake-U SoC 14nm Core™ i7/i5/i3 BGA Type
- NVIDIA GeForce GTX950M
- 12" Glass-Film-Glass Touch panel
- 1300 nits , compatible with Sunlight Readable
- 18V~36V DC-IN, or 12V-40V DC-IN MIL-STD-1275/704 compliant Power Supply (optional)



- **Ultra-High Performance Intel Xeon processor**

Intel Xeon E3-1505L v5:

The Intel Xeon E3-1505L v5 is a 64-bit quad-core x86 high-end quad-core processor. It's part of the Skylake Xeon series. In addition to four CPU cores with Hyper-Threading clocked at 2.0 - 2.8 GHz, the chip also integrates an HD Graphics P530 GPU and a dual-channel DDR4-2133/DDR3L-1600 memory controller. The CPU is manufactured using a 14 nm process with FinFET transistors. The most important difference of the Xeon series compared to consumer models like the Core i7-6920HQ is the support for additional management and security features such as ECC memory.

Architecture:

Skylake replaces both Haswell and Broadwell and brings the same microarchitecture in every TDP class from 4.5 to 45 W. The extensive improvements of the Skylake design include increased out-of-order buffers, optimized prefetching and branch prediction as well as additional performance gains through Hyper-Threading. Overall, however, performance per clock has been increased by only 5 to 10 percent (compared to Haswell) respectively under 5 percent (compared to Broadwell), which is quite modest for a new architecture ("Tock").

Performance:

Thanks to its improved architecture, the E3-1505L v5 performs somewhat better than most Haswellbased predecessors like the Core i7-4900MQ. Under long-lasting full load, the Skylake chip profits by its advanced 14 nm process, which leads to a higher energy efficiency and reduces throttling. Even the most demanding applications and excessive multitasking are handled easily.

Power Consumption:

Specified at a TDP of 25 W (including CPU, GPU and memory controller), the Xeon is best suited for panel PC.

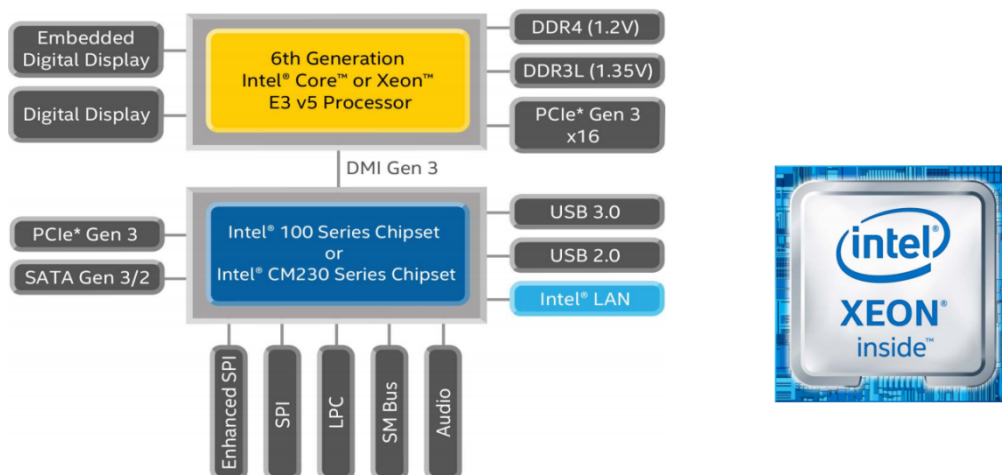

Figure : Intel Xeon E3-1505L v5 Block Diagram

- **NVIDIA GeForce GTX 1050**

NVIDIA GeForce GTX 1050:

The Nvidia GTX 1050 is a mainstream GPU based on the Pascal architecture. Contrary to the faster models, the GTX 1050 uses the GP107 chip, which is manufactured in a 14 nm process at Samsung. It is shipped with up to 4 GB GDDR5-VRAM attached via 128-bit interface and a 7 Gbps memory data rate (112 GB/s).

Highlight:

The GP107 chip is manufactured in a 14 nm FinFET process at Samsung and offers a number of new features, including support for DisplayPort 1.4 (ready), HDMI 2.0b, HDR, Simultaneous MultiProjection (SMP) as well as improved H.265 video de- and encoding (PlayReady 3.0). A full list of improvements and the new Pascal desktop GPUs is available in our dedicated Pascal architecture article.

Performance:

The performance of the GeForce GTX 1050 can vary quite a lot depending on the cooling system. The GeForce GTX 960M is beaten by around 30%. It is therefore an upper mainstream GPU. Monitor can be displayed in high settings an the Full HD resolution.

Power Consumption:

The power consumption of the GeForce GTX 1050 is roughly on par with the old GTX 960M, which would mean around 40-50 Watts and (probably due to better selection and optimized parts) therefore much lower compared to the desktop counterpart.

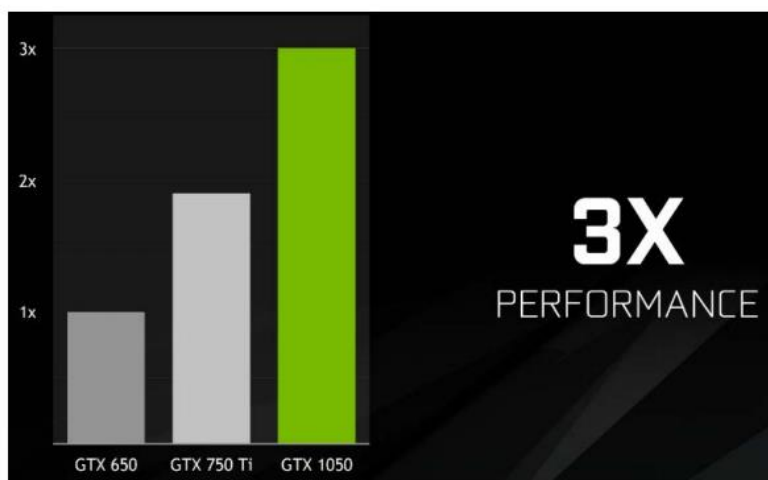
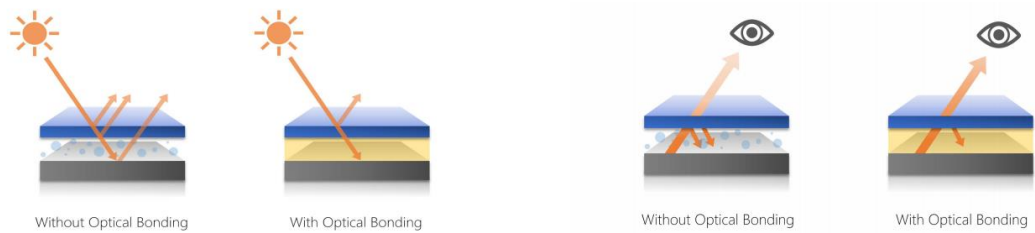

Figure : GTX1050 / GTX750Ti / GTX650 Performance Benchmark

- **LCD Panel:**

Optical Bonding:

Optical bonding technology plays a decisive role in the display which is installed in the highly humid, outdoor, or harsh environments due to its enhanced ruggedness and visual performance to the display. There are some factors that affect displays' readability. The most common one is "fog", or condensation, which forms on the inner surface of display's vandal shield. Another factor is the reflection of sunlight, which causes a mirror-image on the display. Reflection is caused by optical index mismatch between air and the glass. Both issues can be solved by using optical bonding. Not only optical improvement, using optical bonding technology with a protective cover glass can also improve scratch and damage resistance.



Reduction of light reflections and better image quality

The same effect goes the other way

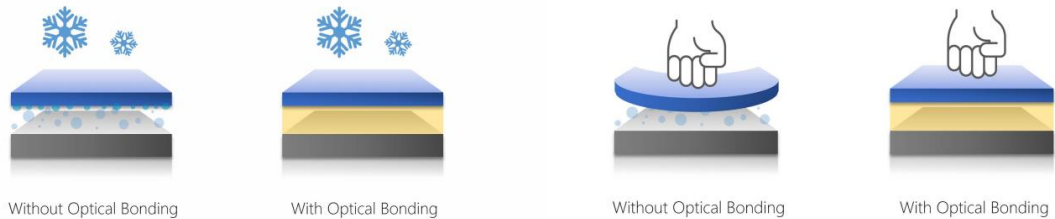

Moisture condensation prevention and dust protection

Increased physical endurance

Ultra Brightness:

Nowadays, displays have been transformed into interactive Human Machine Interfaces (HMI), and as a result, we see more and more outdoor applications appearing. Specifications for outdoor applications are totally different from general displays. For example, when we use a mobile phone which is normally 350 nits outdoors, the screen usually looks washed out or becomes invisible under strong sunlight, the reason being that ambient light is too strong (normally 10,000 nits) causing strong reflections that reduce readability of the screen. Outdoor applications also suffer extreme temperature fluctuations which mist up the screen between the two glass layers (LCD & touch sensor) making the image unclear. To address this issue, high brightness solution is required.

Ultra Brightness:

In direct sunlight, most LCD panels will overheat and will turn black on the panel. We use a special panel with ultra-high brightness that can withstand surface temperatures of up to 70°C without a blackening error, making this number one for Digital Signage in shop windows.

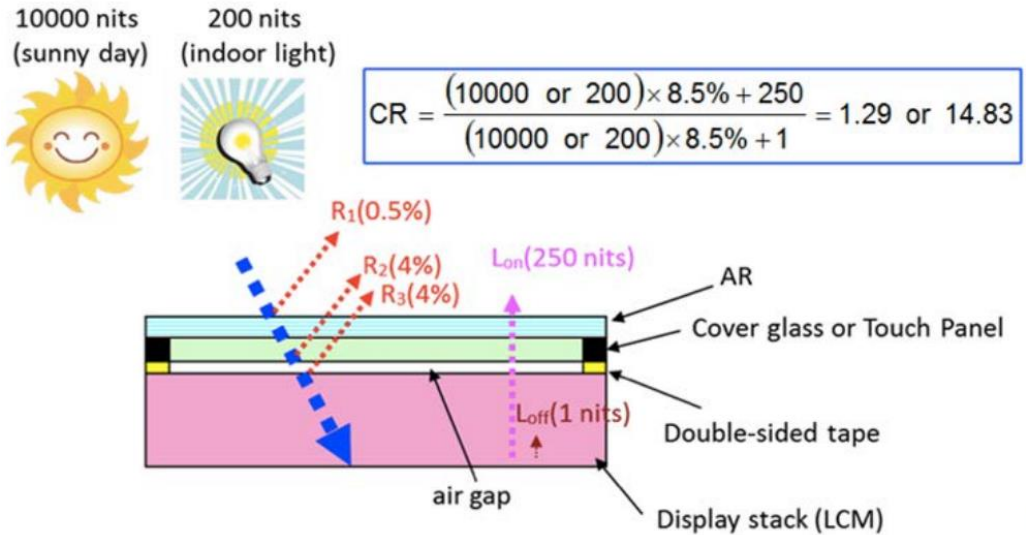

Figure : Ultra Brightness

EMI Shielding Cable Kit:

Electromagnetic Interference (EMI) is prevalent throughout the anywhere. The main purpose of effective EMC Shielding is to prevent electromagnetic interference (EMI) or radio frequency interference (RFI) from impacting sensitive electronics. This is achieved by using a metallic screen to absorb the electromagnetic interference that is being transmitted through the air. The shield effect is based on a principle used in a Faraday cage – the metallic screen completely surrounds either the sensitive electronics or the transmitting electronics. The screen absorbs the transmitted signals, and causes a current within the body of the screen. This current is absorbed by a ground connection, or a virtual ground plane. By absorbing these transmitted signals before they reach the sensitive circuitry, the protected signal is kept clean of electromagnetic interference, maximising shielding effectiveness.



Figure : EMI Shielding Cable Kit

- MIL-STD-1275/704 Power supply with Voltage transient protections**

EMI filter SK710 is designed for rugged extreme, durable metal casing with an isolated MIL-STD-1275, MIL-STD-704 and DO-160 in IP50(dustproof) that protects against vehicle/aircraft voltage surges, spikes and transients is well suited for the strictest military conditions and deliver optimal performance in harsh environment, supports input range from 12V to 40V.

To enhance reliability of SKY12/SKY15, GAIA Hi-Rel DC/DC CONVERTER also provides Undervoltage Lockout (UVLO), Output Over Current Protection (OCP), Output Overvoltage Protection (OVP) and Over Temperature Protection (OTP) to made stability and safety. The module is compliance with MIL-STD-461C/D/E Standards. Furthermore, with parallel design, two SK710 combining can generate double power of 150W, supporting prominent system performance.



Module Compliance with MIL-STD-461C/D/E Standards

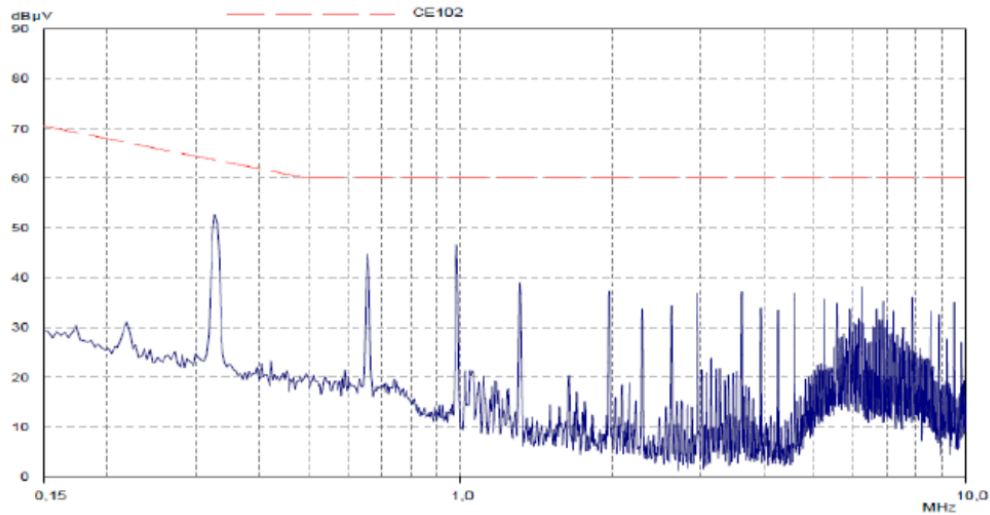

MIL-STD-461E : MGDS-15x-H-J with FGDS-10A-50V

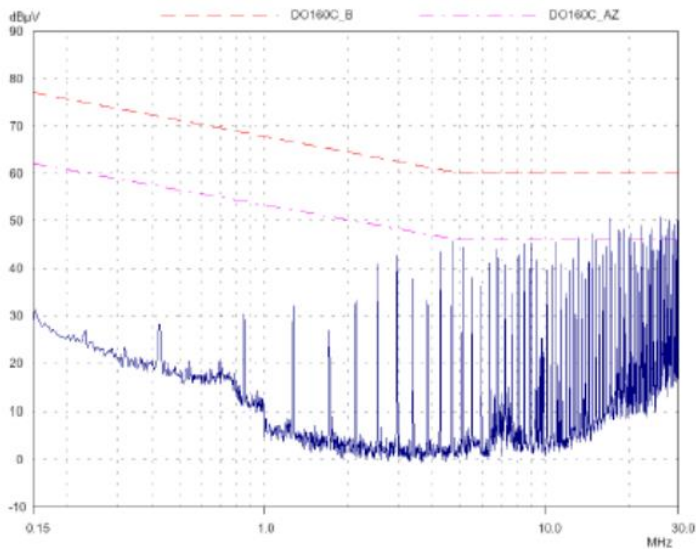

DO-160G : MGDS-15x-H-J with FGDS-10A-50V

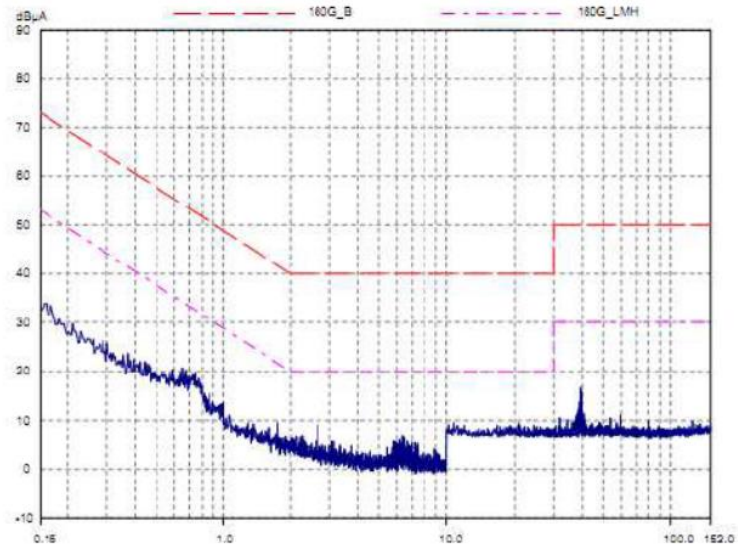

● Description of Key Features

(1) Sunlight Readable Up to 1300 nits



Cloud12-P06 ruggedized smart display can support sunlight-readable to meet high ambient light conditions such as direct sunlight, it also adopt our excellent optic bonding technical process, when bonded together the light passes through the bonded layers and is absorbed somewhat into the screen. Optical bonding is therefore important in making screens sunlight readable.

Normal TFT Sun Readable TFT

(2) Night Vision Mode Support

When system at night mode, the operator can adjust brightness by hard key to turn it to darker, the display brightness down to under 1% nits or other customized night vision mode immediately, and the display gets ready at low brightness right away once its trigger and protect the usage of night vision devices at once.



(3) MIL-DTL 38999



MMIL-DTL-38999 is a high-performance cylindrical connector family designed to withstand the extreme shock, exposure and vibration that are commonplace in Defense

and aerospace applications. Made with removable crimp or fixed hermetic solder contacts, these connectors provide high-vibration characteristics and are suitable for severe wind and moisture problem areas

Amphenol®

(4) Soft Touch Buttons

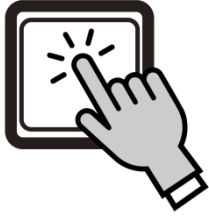

Cloud12-P06 equipped up to 3 ruggedized function keys, 3 OSD keys and 1 power button by rubber-tooling made, each key pad dimension at 16 x 16 mm even the operator access function keys with wearing MOPP levels gloves.

(6) MIL-STD 810G Compliance



Cloud12-P06 compliances of MIL-STD-810 for shocks, vibration etc; **Cloud12-P06** is rigorously field-tested to meet or exceed MIL-STD810G a for extremely high & low temp. humidity, shock, and vibration.

(5) IP65 Certified



Cloud12-P06 has complete resistance to dust and water; which is ruggedized and reliable for constrained military, ground army and defense.

(7) MIL-461/1275 EMI Filter



Cloud12-P06 is designed with MIL-STD-1275/704, protecting against vehicle/aircrafts voltage surges, spikes and transients, and even electromagnetic interference. This characteristic is well suited for the strictest military requirement and deliver optimal performance in harsh conditions.

Specifications

SYSTEM

CPU	Intel® Kabylake-U SoC 14nm Core™ i7/i5/i3 BGA Type Intel® Core™ i7-7600U Processor (2C, 4M Cache, up to 3.9GHz) Intel® Core™ i5-7300U Processor (2C, 3M Cache, up to 3.5GHz) Intel® Core™ i3-7100U Processor (2C, 3M Cache, 2.4GHz)
Memory type	2 x DDR4 up to 32GB ECC memory
Storage	1 x mSATA Solid State Disk (SSD) - up to 512GB Capacity 1 x 2.5" SSD up to 2TB Rugged Industrial NAND Flash Storage -40 to 85oC High Capacity
I/O Connectors	MIL-STD-D38999 Amphenol connectors LAN x 2, DVI x 1, USB x 1, COM x 2, DC-IN x 1
Power Input	18 V~ 36V DC-IN Optional: 12 V ~ 40V DC-IN, MIL-STD-1275, MIL-STD-704 and DO-160 power supply(150W max)
GPU	NVIDIA GeForce GTX950M

DISPLAY

LCD Panel	12" TFT LCD
USB	2 x USB 2.0
Resolution	1024x768 XGA
Aspect Ratio	4:3
Brightness	Ultra Brightness 1300 nits
Max. Colors	16.7M/262k
Viewing Angle	80° (H) /70° (V)
Response Time	11ms (TYP.)
Contrast Ratio	1000 (TYP.)
Touch Pane	Glass-Film-Glass 5-Wire resistor touch panel
Function key	6 user function keys
Display Control	Power On/Off LCD Brightness +/- Function key backlight On/Off Display mode Select (On/Off)

PHYSICAL

Dimension 310 x 90 x 280mm (w/o Stand)
(W x H x D)

Chassis Anodic aluminum oxide

Ingress Protection IP65 Dust /water Proof

ENVIRONMENTAL

Compliance MIL-STD-461E :
CE102 basic curve, 10kHz – 30MHz
RE102-4, (1.5MHz) – 30MHz – 5GHz
RS103, 1.5MHz – 5GHz, 50 V/m equal for all
MIL-STD-1275E :
5.1.2 Starting operation
5.1.3.1.2 Emitted voltage spikes
5.1.3.2.2 Voltage surges
5.1.3.1.1 Voltage spikes
5.1.3.2.1 Voltage surges
5.1.1.2 Voltage ripple
MIL-STD-810G :
Harsh Temperature, Shock, Vibration,
Altitude and Dust

Operating System Windows 10 64bit
Ubuntu16.04, Ubuntu14.04, Fedora 28

Reliability No Moving Parts; Passive Cooling.
Designed & Manufactured using ISO 9001/2000 Certified Quality Program.

EMI/EMC CE ,FCC , MIL-STD-810G, MIL-STD-1275, MIL-SD-461E compliance

Green Product RoHS, WEEE compliance

Ordering Information

Cloud12-P06

12" Rugged Panel Computer, Intel® Kabylake-U SoC 14nm

Core™ i7/i5/i3 BGA Type, MIL-DTL-38999 connectors, 6

Function Keys.

Dimension

